

Airflow direction: blowing

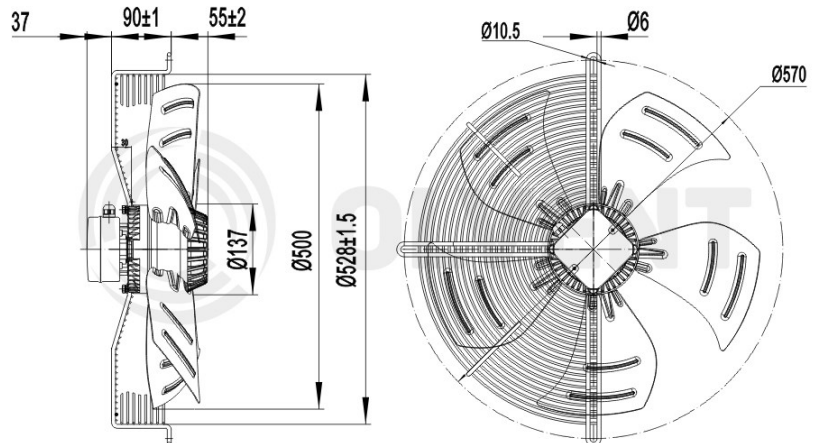

Diameter:	mm	500
Voltage:	V	230
Frequency:	Hz	50
Air flow:	m ³ /h	6500
Speed:	min ⁻¹	1320
Input power:	W	420
Current:	A	2,0
Capacitor:	µF/500 V	10
Sound pressure level:	dB(A)	69
Internal thermal protection :	°C	150±5
Protection class:	IP	54
Compliance with directive ERP:		2015
General efficiency:	ηstatA%	32,81
Efficiency ratio:		41,52
Net weight:	kg	9,0
Gross weight:	kg	11,0
Dimensions of package:	cm	55 x 55 x 22

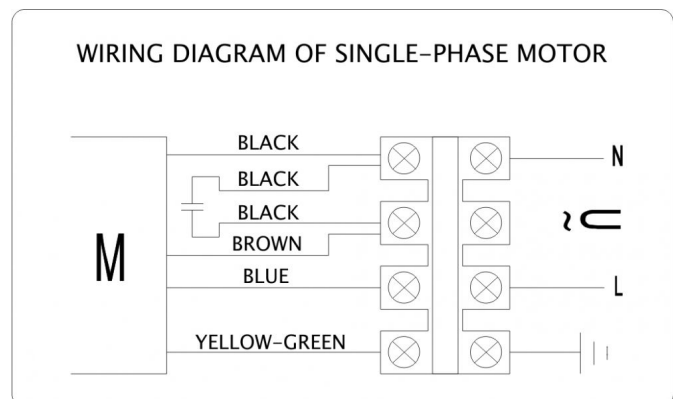
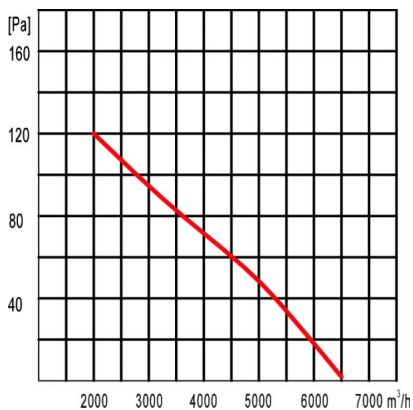

Pictures of some products may vary. Every effort was made to information contained in this catalog are correct. Due to the continuous technological development we reserve the right to make changes without notice.