

Airflow direction: blowing

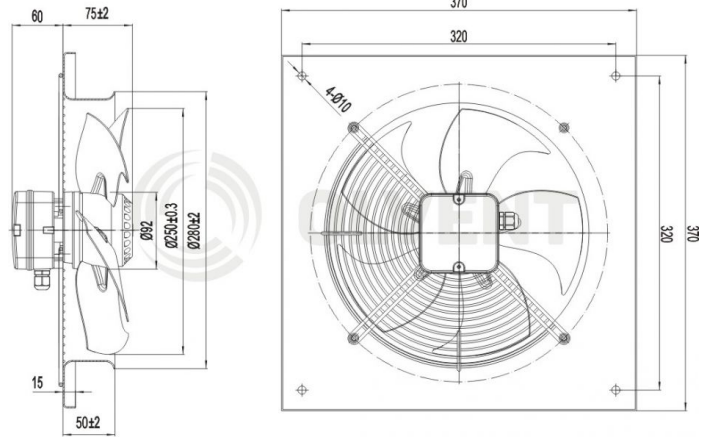

Diameter:	mm	250
Voltage:	V	230
Frequency:	Hz	50
Air flow:	m <sup>3</sup> /h	860
Speed:	min <sup>-1</sup>	1400
Input power:	W	55
Current:	A	0,25
Capacitor:	µF/500 V	2
Sound pressure level:	dB(A)	53
Internal thermal protection :	°C	150±5
Protection class:	IP	44
Net weight:	kg	3,3
Gross weight:	kg	4,0
Dimensions of package:	cm	30 x 30 x 18,5

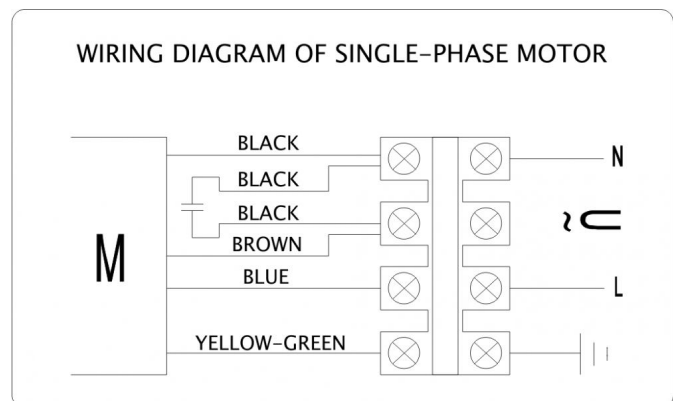
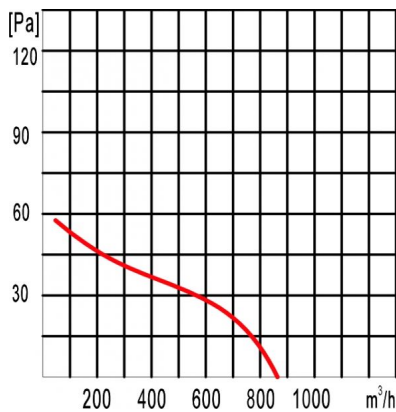

Pictures of some products may vary. Every effort was made to information contained in this catalog are correct. Due to the continuous technological development we reserve the right to make changes without notice.